

# EESTI MV VABA- JA NAISTEMAADLUSES ÕPILASTELE

Põltsamaa Felixhall

29.11.2015

## 32 KG

- 1 NIKITA ŠHIROKOV, Kuldkaru
- 2 SANDER TAGU, Leo
- 3 EGERT AST, Põltsamaa

## 35 KG

- 1 ROBIN JOHANNES PADAR, Jaan
- 2 MARKKO POHLAK, JMM

## 38 KG

- 1 KARMO MÕTUS, Lapiti
- 2 ROBERT MHITARJAN, Aberg
- 3 KRISTO KEERO, Englas
- 3 ROBIN LUMILA, Aberg
- 5 TOM AUNAPUU, Tapa
- 5 KARL-HEINRICH KAJAKAS, Jmm
- 7 MAKSIM SEMBEL, Kuldkaru
- 8 MARK ANISSIMOV, Valga
- 9 KARL-EERIK KAROLES, Englas
- 10 JURI SOOPER, Palusalu

## 42 KG

- 1 MARTIN PÕLD, Kuldkaru
- 2 OLAVI LAISARV, Tapa
- 3 HANNO KÄÄRIK, Lapiti
- 3 RAIMOND UIBO, Leo
- 5 IVAN MAKAROV, Kuldkaru
- 5 KARL-KRISTJAN VALDNA, Kadrina
- 7 KALLE LAISARV, Tapa
- 8 OLIVER SIILBEK, Põltsamaa
- 8 JAANUS SAAR, Leo
- 8 MATVEI STARIKOV, Aberg
- 11 ALEKSANDRS ZAICEVS, Valga

## 47 KG

- 1 ALEKSEI SAULITS, Kuldkaru
- 2 KIRILL SKILLER, Kuldkaru
- 3 KRISTJAN VODOLAZTŠENKO, Juhan
- 3 OLEG TŠABAN, Aberg
- 5 REMO OJASTE, V-M
- 5 PENNO PALL, Põltsamaa
- 7 VLADISLAV NESTERENKO, Valga
- 8 OLEKSANDR ŽHUPANOV, Palusalu
- 9 KRISTJAN MARKKO ARUVALD, Aberg
- 10 MIKO MÄGISALU, SKP
- 10 RONALD-HOSS RÜCKENBERG, JMM
- 10 KAIMAR TAMM, Tulevik
- 13 RAGNAR KUURMAA, JMM
- 14 RAINER-KEVIN SUUDER, Tulevik

## 53 KG

- 1 EDVIN KIN, Nelson
- 2 MARKOS TADOLDER, Jaan
- 3 JEGOR SAHNO, Tapa
- 3 HELAR OKAS, JMM
- 5 RICHARD KHOLIN, Nelson
- 5 INGVAR HINNO, Kadrina
- 7 SIIM MARTIN ESKLA, Ramm
- 8 ELMAR BRAKS, JMM
- 9 DANIK PETROV, Palusalu
- 10 KRISTJAN METSOJA, Tapa
- 11 OLEG LUKJANOV, Kuldkaru

## 59 KG

- 1 KRISTO VIIDAS, Nelson
- 2 SILVER KÄNNA, Lapiti
- 3 MARKUS JULJUS HOLMBERG, Kadrina
- 3 KALMER KUKK, Tartumaa
- 5 SILVER RUMP, Põltsamaa
- 5 ALLAN-DEVID ŠEVTŠOV, Leo
- 7 KAIMAR ASU, Tulevik
- 8 RAINER KLEINOD, Leola
- 9 TAURI LAIDRO, K-J Kalev
- 10 TEET MURULA, Väandra
- 11 STEFAN BORISSOV, Leo
- 12 KENNET KÜNNARPUU, JMM
- 12 MATTI MATIAS SIUULA, EMÜ
- 12 KERMO KIVIOJA, EMÜ

## 66 KG

- 1 NIKITA TSEHHONIN, Kuldkaru
- 2 JARMO VANMIK, Juhan
- 3 TAURI ALTMÄE, Kadrina
- 3 ANDRIS PENT, V-M
- 5 KEVIN KREDEMANN, Tulevik
- 5 SANDER ROOSILEHT, Juhan
- 7 MARKUS AAS, Tulevik
- 8 MAKSIM TARASSOV, Kuldkaru
- 9 MATTIAS MÄE, Wesenberg
- 10 TANEL ARMI, Tartumaa
- 10 RICHARD LAISAAR, Kadrina
- 12 PEEP-PRIIDIK JALAS, JMM
- 12 ERKO LILLETAI, JMM
- 12 EIGO PESTI, JMM
- 15 ROBERT NEMSITSVERIDSE, Englas

## 73 KG

- 13 ALVAR NOVIKOV, SKP
- 1 JAKO KIVIMÄGI, Põltsamaa
- 2 AHO LEITHAM, K.Palusalu SK
- 3 ANVAR SILD, Kadrina
- 3 SILVER ROOSILEHT, Juhan
- 5 ILYA RUBINOV, Rakvere
- 5 RAIDO REHEPAPP, Juhan
- 7 OTT HELISTE, TÜ ASK
- 8 MARKUS KRIISKÜTT, Lapiti
- 9 MIKK SIKKAR, V-M
- 10 SANDER REEMETS, EMÜ
- 11 TANEL PÕRK, Valga
- 12 JEVGENI MELNIK, Aberg
- 14 MADIS KANGUR, K-J Kalev
- 14 ATS PAJULA, Tapa

## 85 KG

- 1 GEORG KOVZAROV, Aberg
- 2 NIKITA VINOGRADOV, Dünamo
- 3 GREGOR NAATAN SOONE, Aberg
- 3 VIRMO TAMMEMÄGI, V-M
- 5 ROBIN KUKK, Rakvere
- 5 RUDOLF PRAGI, Lapiti
- 7 RICHARD KARELSON, Nelson
- 8 JAKKO RAIK, K-J Kalev
- 9 ARTUR RAKITIN, Delta

## T37 KG

- 1 JANA DEINEKIN, Ramm

## T44 KG

- 1 TIIA-TRIIN TOMSON, Leo
- 2 TRIINULY VEIMANN, Juhan
- 3 JONETE VISNAPUU, V-M
- 3 POLINA SAHNO, Tapa
- 5 MARET KANE, Juhan
- 5 MAARJA PLASER, Korrus 3
- 7 EVA KOVALJOVA, Palusalu
- 8 SANDRA LEPPIK, Valga

## T 52 KG

- 1 LAURA PÕDER, Valga
- 2 NELE TRUBER, Korrus 3
- 3 JELISAVETA TŠUVPILO, Tapa
- 3 ANASTASSIA KRUGLOVA,
- 5 HEILY TIITUS, Juhan
- 5 MARITE LILLEPA, JMM
- 7 MAARJA-LIIS NIRGI, V-M
- 8 KÜLLY JÕGI, Tulevik

## T 62 KG

- 1 VIKTORIA VESSO, EMÜ
- 2 MARTA PAJULA, Tapa
- 3 TEELE-HELENA PALU, Tulevik
- 3 KÄROLY SEEMANN, V-M
- 5 VLADLENA STEPTSENKO, Põltsamaa
- 5 KARMEN KUKK, Wesenberg
- 7 RAGNE KUURMAA, JMM

EESTI MV VABA- JA NAISTEMAADLUSES ÕPILASTELE

Põltsamaa Felixhall

29.11.2015

Weight category	32	kg
-----------------	----	----

Nr	Name	Weight	Country	Pools competitions									Points	Place
				1.round			2.round			3.round			Kval.	
					Passivity	Time		Passivity	Time		Passivity	Time	Tehn.	
<b>1.pool</b>														
1	EGERT AST, Põltsamaa			2	0			3	0			x	0	3
					0				4				4	
2	NIKITA ŠHIROKOV, Kuldkaru			1	4			x				3	4	8
					8	SV							4	12
3	SANDER TAGU, Leo			x				1	4			2	0	4
									4	sv			0	4
													4	2
													4	

CHIEF OF OFFICIALS	Vello Aava
CHIEF OF SECRETARY	Kättri-Avelin Säärits

EESTI MV VABA- JA NAISTEMAADLUSES ÕPILASTELE  
Põitsamaa Felixhall  
29.11.2015

Weight category	<b>35</b>	kg
-----------------	-----------	----

Nr	Name	Weight	Country	Pools competitions								Points	Place	
				1.round								Kval.		
					Passivity	Time								Tehn.
<b>1.pool</b>														
1	ROBIN JOHANNES PADAR, Jaan			<b>2</b>	4				—				4	<b>1</b>
					4	SV							4	
2	MARKKO POHLAK, JMM			<b>1</b>	0						—		0	<b>2</b>
					0								0	

CHIEF OF OFFICIALS	Vello Aava
CHIEF OF SECRETARY	Kättri-Avelin Säärirts

# EESTI MV VABA- JA NAISTEMAADLUSES ÕPILASTELE

Põltsamaa Felixhall

29.11.2015

Weight category Kaal

38 KG

Place Koht	Tour Préliminaire Eelring	1/4 Finale 1/4 Finaal	1/2 Finale 1/2 Finaal	Finale 1.-2. Finaal 1.-2.							
5	1 TOM AUNAPUU, Tapa	1 TOM AUNAPUU, Tapa <table border="1"><tr><td>0</td><td>0</td></tr></table>	0	0	2 ROBERT MHITARJAN, Aberg <table border="1"><tr><td>4</td><td>12</td></tr></table>	4	12	2 ROBERT MHITARJAN, Aberg <table border="1"><tr><td>1</td><td>7</td></tr></table>	1	7	5 KARMO MÕTUS, Lapiti
0	0										
4	12										
1	7										
2	2 ROBERT MHITARJAN, Aberg	2 ROBERT MHITARJAN, Aberg <table border="1"><tr><td>4</td><td>10</td></tr></table>	4	10							
4	10										
3	3 KRISTO KEERO, Englas	3 KRISTO KEERO, Englas <table border="1"><tr><td>4</td><td>12</td></tr></table>	4	12	3 KRISTO KEERO, Englas <table border="1"><tr><td>1</td><td>2</td></tr></table>	1	2				
4	12										
1	2										
10	4 JURI SOOPER, Palusalu <table border="1"><tr><td>0</td><td>0</td><td>12</td></tr></table>	0	0	12	4 JURI SOOPER, Palusalu <table border="1"><tr><td>0</td><td>0</td></tr></table>	0	0				
0	0	12									
0	0										
1	5 KARMO MÕTUS, Lapiti	5 KARMO MÕTUS, Lapiti <table border="1"><tr><td>4</td><td>10</td></tr></table>	4	10	5 KARMO MÕTUS, Lapiti <table border="1"><tr><td>4</td><td>10</td></tr></table>	4	10	5 KARMO MÕTUS, Lapiti <table border="1"><tr><td>3</td><td>11</td></tr></table>	3	11	
4	10										
4	10										
3	11										
5	6 KARL-HEINRICH KAJAKAS, Jmm	6 KARL-HEINRICH KAJAKAS, Jmm <table border="1"><tr><td>0</td><td>0</td></tr></table>	0	0							
0	0										
9	7 KARL-EERIK KAROLES, Englas <table border="1"><tr><td>0</td><td>4</td><td>4</td></tr></table>	0	4	4	8 MAKSIM SEMBEL, Kuldkaru <table border="1"><tr><td>0</td><td>2</td></tr></table>	0	2				
0	4	4									
0	2										
7	8 MAKSIM SEMBEL, Kuldkaru <table border="1"><tr><td>5</td><td>6</td><td>11</td></tr></table>	5	6	11	8 MAKSIM SEMBEL, Kuldkaru <table border="1"><tr><td>5</td><td>4</td></tr></table>	5	4	9 ROBIN LUMILA, Aberg <table border="1"><tr><td>0</td><td>0</td></tr></table>	0	0	
5	6	11									
5	4										
0	0										
3	9 ROBIN LUMILA, Aberg <table border="1"><tr><td>3</td><td>8</td></tr></table>	3	8	9 ROBIN LUMILA, Aberg <table border="1"><tr><td>5</td><td>7</td></tr></table>	5	7					
3	8										
5	7										
8	10 MARK ANISSIMOV, Valga <table border="1"><tr><td>1</td><td>2</td><td>8</td></tr></table>	1	2	8							
1	2	8									

CHIEF OF OFFICIALS  
CHIEF OF SECRETARY

Vello Aava  
Kättri-Avelin Säärts

## REPECHAGE / LOHUTUSRINGID

Perdants contre le 1er Finaliste  
Esimesele finalistile kaotajad

Perdants contre le 2ème Finaliste  
Teisele finalistile kaotajad

1	TOM AUNAPUU, Tapa	<table border="1"><tr><td>0</td><td>0</td></tr></table>	0	0
0	0			
3	KRISTO KEERO, Englas	<table border="1"><tr><td>5</td><td>6</td></tr></table>	5	6
5	6			

6	KARL-HEINRICH KAJAKAS, Jmm	<table border="1"><tr><td>0</td><td>4</td></tr></table>	0	4
0	4			
9	ROBIN LUMILA, Aberg	<table border="1"><tr><td>5</td><td>4</td></tr></table>	5	4
5	4			

Médaille de Bronze  
Pronksmedali võitja

3 KRISTO KEERO, Englas

Médaille de Bronze  
Pronksmedali võitja

9 ROBIN LUMILA, Aberg

# EESTI MV VABA- JA NAISTEMAADLUSES ÕPILASTELE

Põltsamaa Felixhall

29.11.2015

Kaal

42 KG

Place Koht	Tour Préliminaire Eelring	1/4 Finale 1/4 Finaal	1/2 Finale 1/2 Finaal	Finale 1.-2. Finaal 1.-2.														
3	1 HANNO KÄÄRIK, Lapiti	1 HANNO KÄÄRIK, Lapiti <table border="1"><tr><td>4</td><td>10</td></tr></table>	4	10	1 HANNO KÄÄRIK, Lapiti <table border="1"><tr><td>0</td><td>0</td></tr></table>	0	0	<table border="1"> <tr> <td>3</td> <td>OLAVI LAISARV, Tapa</td> <td><table border="1"><tr><td>0</td><td>0</td></tr></table></td> </tr> <tr> <td>10</td> <td>MARTIN PÕLD, Kuldkaru</td> <td><table border="1"><tr><td>4</td><td>10</td></tr></table></td> </tr> </table>	3	OLAVI LAISARV, Tapa	<table border="1"><tr><td>0</td><td>0</td></tr></table>	0	0	10	MARTIN PÕLD, Kuldkaru	<table border="1"><tr><td>4</td><td>10</td></tr></table>	4	10
4	10																	
0	0																	
3	OLAVI LAISARV, Tapa	<table border="1"><tr><td>0</td><td>0</td></tr></table>	0	0														
0	0																	
10	MARTIN PÕLD, Kuldkaru	<table border="1"><tr><td>4</td><td>10</td></tr></table>	4	10														
4	10																	
8	2 OLIVER SIILBEK, Põltsamaa	2 OLIVER SIILBEK, Põltsamaa <table border="1"><tr><td>0</td><td>0</td></tr></table>	0	0	3 OLAVI LAISARV, Tapa <table border="1"><tr><td>5</td><td>4</td></tr></table>	5	4											
0	0																	
5	4																	
2	3 OLAVI LAISARV, Tapa	3 OLAVI LAISARV, Tapa <table border="1"><tr><td>5</td><td>2</td></tr></table>	5	2	7 RAIMOND UIBO, Leo <table border="1"><tr><td>0</td><td>0</td></tr></table>	0	0											
5	2																	
0	0																	
5	4 IVAN MAKAROV, Kuldkaru	4 IVAN MAKAROV, Kuldkaru <table border="1"><tr><td>0</td><td>0</td></tr></table>	0	0	10 MARTIN PÕLD, Kuldkaru <table border="1"><tr><td>4</td><td>10</td></tr></table>	4	10											
0	0																	
4	10																	
7	5 KALLE LAISARV, Tapa	5 KALLE LAISARV, Tapa <table border="1"><tr><td>1</td><td>3</td></tr></table>	1	3														
1	3																	
8	6 JAANUS SAAR, Leo <table border="1"><tr><td>0</td><td>0</td></tr></table>	0	0	7 RAIMOND UIBO, Leo <table border="1"><tr><td>3</td><td>6</td></tr></table>	3	6												
0	0																	
3	6																	
3	7 RAIMOND UIBO, Leo <table border="1"><tr><td>5</td><td>10</td></tr></table>	5	10	8 KARL-KRISTJAN VALDNA, Kadrina <table border="1"><tr><td>0</td><td>0</td></tr></table>	0	0												
5	10																	
0	0																	
5	8 KARL-KRISTJAN VALDNA, Kadrina <table border="1"><tr><td>4</td><td>10</td></tr></table>	4	10	10 MARTIN PÕLD, Kuldkaru <table border="1"><tr><td>5</td><td>4</td></tr></table>	5	4												
4	10																	
5	4																	
8	9 MATVEI STARIKOV, Aberg <table border="1"><tr><td>0</td><td>0</td></tr></table>	0	0															
0	0																	
1	10 MARTIN PÕLD, Kuldkaru <table border="1"><tr><td>4</td><td>12</td></tr></table>	4	12															
4	12																	
11	11 ALEKSANDRS ZAICEVS, Valga <table border="1"><tr><td>0</td><td>0</td></tr></table>	0	0															
0	0																	

CHIEF OF OFFICIALS  
CHIEF OF SECRETARY

Vello Aava  
Kättri-Avelin Säärits

## REPECHAGE / LOHUTUSRINGID

Perdants contre le 1er Finaliste  
Esimesele finalistile kaotajad

Perdants contre le 2ème Finaliste  
Teisele finalistile kaotajad

	4 IVAN MAKAROV, Kuldkaru <table border="1"><tr><td>0</td><td>0</td></tr></table>	0	0	11 ALEKSANDRS ZAICEVS, Valga <table border="1"><tr><td>0</td><td>0</td></tr></table>	0	0	8 KARL-KRISTJAN VALDNA, <table border="1"><tr><td>0</td><td>6</td></tr></table>	0	6
0	0								
0	0								
0	6								
	1 HANNO KÄÄRIK, Lapiti <table border="1"><tr><td>5</td><td>4</td></tr></table>	5	4	8 KARL-KRISTJAN VALDNA, <table border="1"><tr><td>5</td><td>4</td></tr></table>	5	4	7 RAIMOND UIBO, Leo <table border="1"><tr><td>5</td><td>8</td></tr></table>	5	8
5	4								
5	4								
5	8								
Médaille de Bronze Pronksmedali võitja	1 HANNO KÄÄRIK, Lapiti	Médaille de Bronze Pronksmedali võitja	7 RAIMOND UIBO, Leo						

# EESTI MV VABA- JA NAISTEMAADLUSES ÕPILASTELE

Põltsamaa Felixhall

29.11.2015

Weight category  
Kaal  
47 KG

Place Koht	Tour Préliminaire Eelring	1/4 Finale 1/4 Finaal	1/2 Finale 1/2 Finaal	Finale 1.-2. Finaal 1.-2.	Weight category Kaal 47 KG
9	0 0 6	1 KRISTJAN MARKKO ARUVALD, Aberg	1 KRISTJAN MARKKO ARUVALD, Aberg	2 REMO OJASTE, V-M	
5		2 REMO OJASTE, V-M	2 REMO OJASTE, V-M	4 ALEKSEI SAULITS, Kuldkaru	
13	0 0 14	3 RAGNAR KUURMAA, JMM	4 ALEKSEI SAULITS, Kuldkaru	4 ALEKSEI SAULITS, Kuldkaru	
1		4 ALEKSEI SAULITS, Kuldkaru	4 ALEKSEI SAULITS, Kuldkaru	4 ALEKSEI SAULITS, Kuldkaru	
3		5 KRISTJAN VODOLAZTŠENKO, Juhan	5 KRISTJAN VODOLAZTŠENKO, Juhan		
8	0 0 2	6 OLEKSANDR ŽHUPANOV, Palusalu			
5		7 PENNO PALL, Põltsamaa	7 PENNO PALL, Põltsamaa		
10	0 0 10	8 MIKO MÄGISALU, SKP		7 PENNO PALL, Põltsamaa	
7	4 12 6	9 VLADISLAV NESTERENKO, Valga	9 VLADISLAV NESTERENKO, Valga		
10	0 0 10	10 RONALD-HOSS RÜCKENBERG, JMM		12 KIRILL SKILLER, Kuldkaru	
14	0 0 18	11 RAINER-KEVIN SUUDER, Tulevik	12 KIRILL SKILLER, Kuldkaru	12 KIRILL SKILLER, Kuldkaru	
2		12 KIRILL SKILLER, Kuldkaru	12 KIRILL SKILLER, Kuldkaru		
10	0 0 10	13 KAIMAR TAMM, Tulevik	14 OLEG TŠABAN, Aberg		
3		14 OLEG TŠABAN, Aberg			

CHIEF OF OFFICIALS

Vello Aava

CHIEF OF SECRETARY

Kätri-Avelin Säarits

## REPECHAGE / LOHUTUSRINGID

Perdants contre le 1er Finaliste

Esimesele finalistile kaotajad

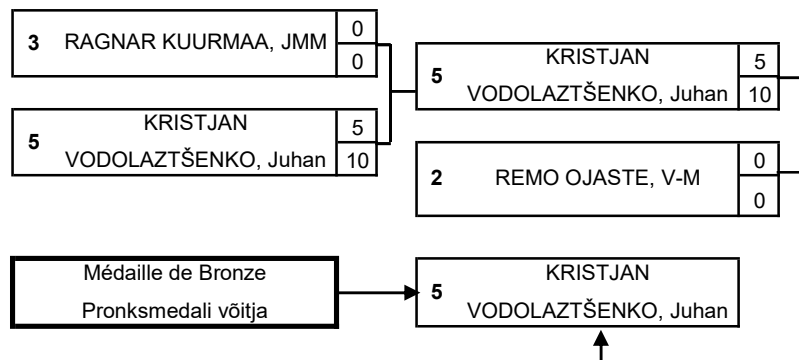

Perdants contre le 2ème Finaliste

Teisele finalistile kaotajad

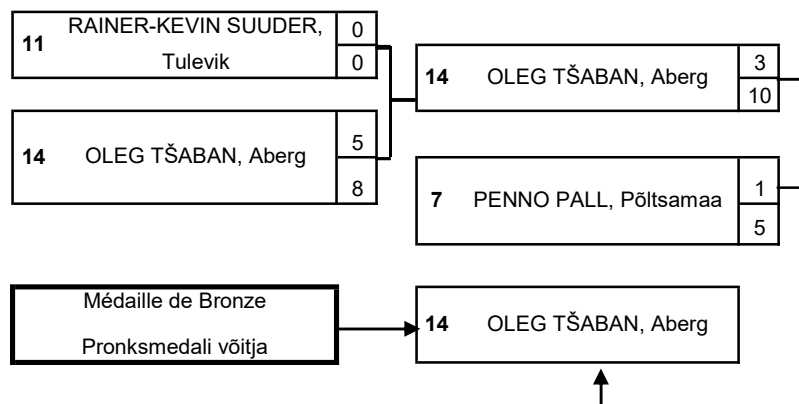

# EESTI MV VABA- JA NAISTEMAADLUSES ÕPILASTELE

Põltsamaa Felixhall

29.11.2015

Kaal  
53 KG

Place Koht	Tour Préliminaire Eelring	1/4 Finale 1/4 Finaal	1/2 Finale 1/2 Finaal	Finale 1.-2. Finaal 1.-2.
5	1 RICHARD KHOLIN, Nelson	1 RICHARD KHOLIN, Nelson <span style="float:right">0 0</span>	2 MARKOS TADOLDER, Jaan <span style="float:right">5 4</span>	2 MARKOS TADOLDER, Jaan <span style="float:right">0 0</span>
2	2 MARKOS TADOLDER, Jaan	2 MARKOS TADOLDER, Jaan <span style="float:right">5 6</span>	4 JEGOR SAHNO, Tapa <span style="float:right">0 0</span>	
8 <span style="float:right">0 4 5</span>	3 ELMAR BRAKS, JMM	3 ELMAR BRAKS, JMM <span style="float:right">0 4</span>	5 HELAR OKAS, JMM <span style="float:right">0 0</span>	9 EDVIN KIN, Nelson
3	4 JEGOR SAHNO, Tapa	4 JEGOR SAHNO, Tapa <span style="float:right">5 5</span>	9 EDVIN KIN, Nelson <span style="float:right">5 10</span>	
3	5 HELAR OKAS, JMM	5 HELAR OKAS, JMM <span style="float:right">5 2</span>	9 EDVIN KIN, Nelson <span style="float:right">4 11</span>	
9 <span style="float:right">0 0 2</span>	6 DANIK PETROV, Palusalu <span style="float:right">0 0</span>	7 SIIM MARTIN ESKLA, Ramm <span style="float:right">0 0</span>		
7 <span style="float:right">5 2 2</span>	7 SIIM MARTIN ESKLA, Ramm <span style="float:right">5 2</span>			
11 <span style="float:right">0 0 12</span>	8 OLEG LUKJANOV, Kuldkaru <span style="float:right">0 0</span>	9 EDVIN KIN, Nelson <span style="float:right">4 10</span>		
1	9 EDVIN KIN, Nelson <span style="float:right">4 10</span>			
10 <span style="float:right">0 0 10</span>	10 KRISTJAN METSOJA, Tapa <span style="float:right">0 0</span>	11 INGVAR HINNO, Kadrina <span style="float:right">0 0</span>		
5	11 INGVAR HINNO, Kadrina <span style="float:right">4 10</span>			

CHIEF OF OFFICIALS  
CHIEF OF SECRETARY

Vello Aava  
Kättri-Avelin Säärts

## REPECHAGE / LOHUTUSRINGID

Perdants contre le 1er Finaliste  
Esimesele finalistile kaotajad

Perdants contre le 2ème Finaliste  
Teisele finalistile kaotajad

1 RICHARD KHOLIN, Nelson <span style="float:right">0 0</span>
4 JEGOR SAHNO, Tapa <span style="float:right">4 12</span>

8 OLEG LUKJANOV, Kuldkaru <span style="float:right">0 0</span>
11 INGVAR HINNO, Kadrina <span style="float:right">5 2</span>

11 INGVAR HINNO, Kadrina <span style="float:right">0 0</span>
5 HELAR OKAS, JMM <span style="float:right">5 6</span>

Médaille de Bronze  
Pronksmedali võitja

4 JEGOR SAHNO, Tapa

Médaille de Bronze  
Pronksmedali võitja

5 HELAR OKAS, JMM



# EESTI MV VABA- JA NAISTEMAADLUSES ÕPILASTELE

Põltsamaa Felixhall

29.11.2015

Weight category  
Kaal

59 kg

Place Koht	Tour Préliminaire Eelring	1/4 Finale 1/4 Finaal	1/2 Finale 1/2 Finaal	Finale 1.-2. Finaal 1.-2.
12	0 0 10	1 KERMO KIVIOJA, EMÜ	1 KERMO KIVIOJA, EMÜ 0 0	2 SILVER RUMP, Põltsamaa 0 6
5		2 SILVER RUMP, Põltsamaa	2 SILVER RUMP, Põltsamaa 4 10	
12	0 0 10	3 KENNET KÜNNARPUU, JMM	4 KAIMAR ASU, Tulevik 1 2	5 KRISTO VIIDAS, Nelson 4 10
7	5 12 18	4 KAIMAR ASU, Tulevik	5 KRISTO VIIDAS, Nelson 5 4	
1		5 KRISTO VIIDAS, Nelson	5 KRISTO VIIDAS, Nelson 4 12	5 KRISTO VIIDAS, Nelson 4 10
3		6 MARKUS JULJUS HOLMBERG, Kadrina		
3		7 KALMER KUKK, Tartumaa	7 KALMER KUKK, Tartumaa 5 11	7 KALMER KUKK, Tartumaa 0 5
10	0 0 4	8 TEET MURULA, Vädra		
11	0 0 6	9 STEFAN BORISSOV, Leo	10 RAINER KLEINOD, Leola 0 5	14 SILVER KÄNNA, Lapiti 0 0
8	5 11 11	10 RAINER KLEINOD, Leola		
12	0 0 10	11 MATTI MATIAS SIUULA, EMÜ	12 ALLAN-DEVID ŠEVTŠOV, Leo	14 SILVER KÄNNA, Lapiti 5 4
5		12 ALLAN-DEVID ŠEVTŠOV, Leo		
9	1 1 16	13 TAURI LAIDRO, K-J Kalev	14 SILVER KÄNNA, Lapiti 4 13	
2		14 SILVER KÄNNA, Lapiti		5 KRISTO VIIDAS, Nelson

CHIEF OF OFFICIALS

Vello Aava

CHIEF OF SECRETARY

Kättri-Avelin Säärits

## REPECHAGE / LOHUTUSRINGID

### Perdants contre le 1er Finaliste

#### Esimesele finalistile kaotajad

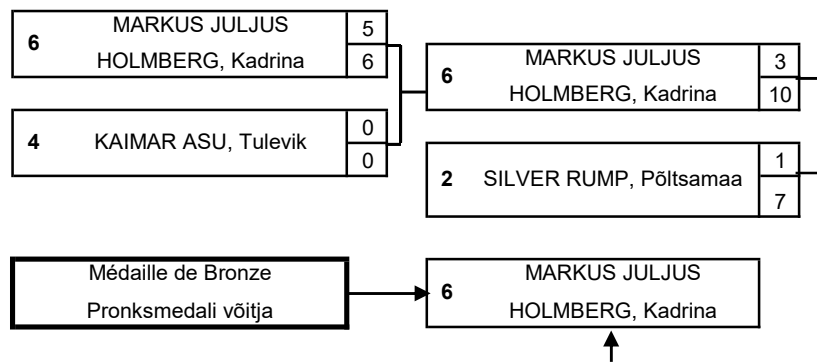

### Perdants contre le 2ème Finaliste

#### Teisele finalistile kaotajad

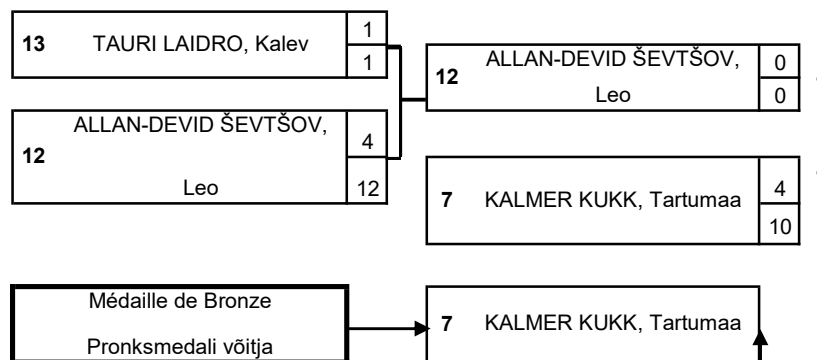

# EESTI MV VABA- JA NAISTEMAADLUSES ÕPILASTELE

Põltsamaa Felixhall

29.11.2015

Weight category  
Kaal

66 KG

Place Koht	Tour Préliminaire Eelring	1/4 Finale 1/4 Finaal	1/2 Finale 1/2 Finaal	Finale 1.-2. Finaal 1.-2.	Weight category Kaal
2	1 JARMO VANMIK, Juhan	1 JARMO VANMIK, Juhan	1 JARMO VANMIK, Juhan	1 JARMO VANMIK, Juhan	66 KG
10	2 TANEL ARMI, Tartumaa	3 KEVIN KREEDEMANN, Tulevik			
5	3 KEVIN KREEDEMANN, Tulevik				
10	4 RICHARD LAISAAR, Kadrina	5 MARKUS AAS, Tulevik	6 TAURI ALTMÄE, Kadrina		
7	5 MARKUS AAS, Tulevik				
3	6 TAURI ALTMÄE, Kadrina	6 TAURI ALTMÄE, Kadrina			
12	7 PEEP-PRIIDIK JALAS, JMM				
1	8 NIKITA TSEHHONIN, Kuldkaru	8 NIKITA TSEHHONIN, Kuldkaru	8 NIKITA TSEHHONIN, Kuldkaru	8 NIKITA TSEHHONIN, Kuldkaru	
5	9 SANDER ROOSILEHT, Juhan				
9	10 MATTIAS MÄE, Wesenberg	10 MATTIAS MÄE, Wesenberg			
12	11 ERKO LILLETAI, JMM				
8	12 MAKSIM TARASSOV, Kuldkaru	12 MAKSIM TARASSOV, Kuldkaru	14 ANDRIS PENT, V-M		
12	13 EIGO PESTI, JMM				
3	14 ANDRIS PENT, V-M	14 ANDRIS PENT, V-M			
15	15 ROBERT NEMSITSVERIDSE, Englas				

CHIEF OF OFFICIALS

Vello Aava

CHIEF OF SECRETARY

Kättri-Avelin Säärits

## REPECHAGE / LOHUTUSRINGID

Perdants contre le 1er Finaliste

Esimesele finalistile kaotajad

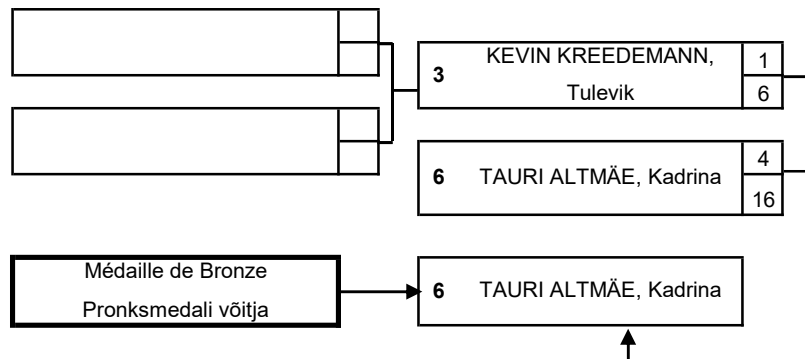

Perdants contre le 2ème Finaliste

Teisele finalistile kaotajad

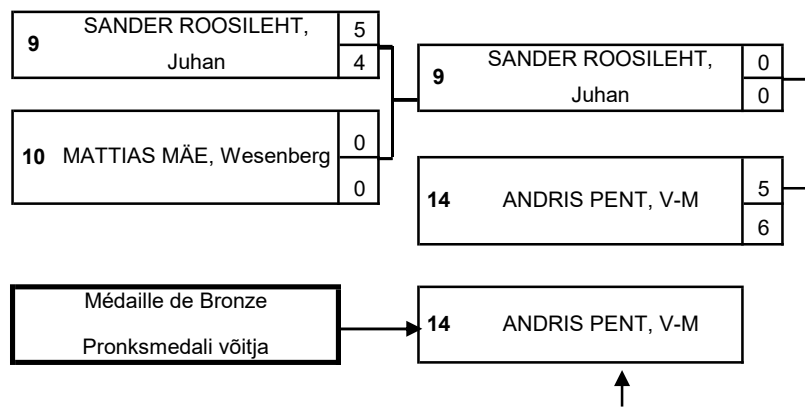

# EESTI MV VABA- JA NAISTEMAADLUSES ÕPILASTELE

Põltsamaa Felixhall

29.11.2015

Weight category  
Kaal 73 kg

Place Koht	Tour Préliminaire Eelring	1/4 Finale 1/4 Finaal	1/2 Finale 1/2 Finaal	Finale 1.-2. Finaal 1.-2.
13	0 0 8	1 ALVAR NOVIKOV, SKP	1 ALVAR NOVIKOV, SKP	
1		2 JAKO KIVIMÄGI, Põltsamaa	2 JAKO KIVIMÄGI, Põltsamaa	2 JAKO KIVIMÄGI, Põltsamaa
5		3 ILYA RUBINOV, Rakvere		
3		4 ANVAR SILD, Kadrina	4 ANVAR SILD, Kadrina	
10	0 4 8	5 SANDER REEMETS, EMÜ	4 ANVAR SILD, Kadrina	
7	4 18 6	6 OTT HELISTE, TÜ ASK	6 OTT HELISTE, TÜ ASK	2 JAKO KIVIMÄGI, Põltsamaa
14	0 0 10	7 MADIS KANGUR, K-J Kalev		
5		8 RAIDO REHEPAPP, Juhan	8 RAIDO REHEPAPP, Juhan	
12	0 0 2	9 JEVGENI MELNIK, Aberg	8 RAIDO REHEPAPP, Juhan	12 AHO LEITHAM, K.Palusalu SK
8	4 10 8	10 MARKUS KRIISKÜTT, Lapiti	10 MARKUS KRIISKÜTT, Lapiti	
14	0 0 10	11 ATS PAJULA, Tapa		
2		12 AHO LEITHAM, K.Palusalu SK	12 AHO LEITHAM, K.Palusalu SK	12 AHO LEITHAM, K.Palusalu SK
11	0 2 10	13 TANEL PÕRK, Valga	12 AHO LEITHAM, K.Palusalu SK	
3		14 SILVER ROOSILEHT, Juhan	14 SILVER ROOSILEHT, Juhan	
9	0 4 6	15 MIKK SIKKAR, V-M		

CHIEF OF OFFICIALS  
CHIEF OF SECRETARY

Vello Aava  
Kättri-Avelin Säärts

## REPECHAGE / LOHUTUSRINGID

### Perdants contre le 1er Finaliste

#### Esimesele finalistile kaotajad

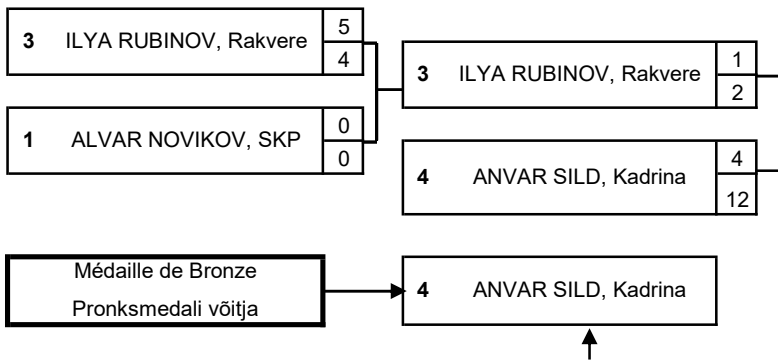

### Perdants contre le 2ème Finaliste

#### Teisele finalistile kaotajad

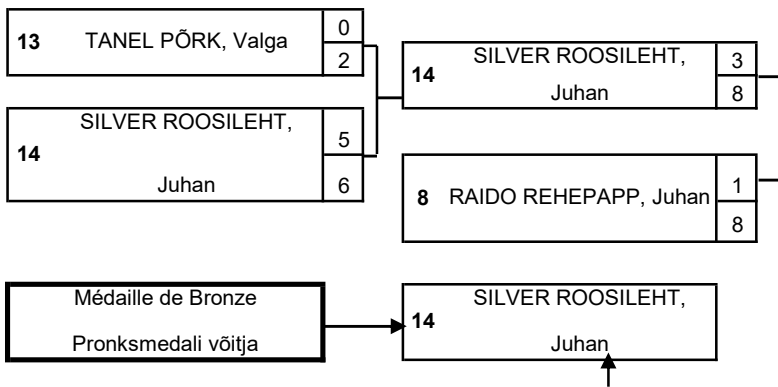

# EESTI MV VABA- JA NAISTEMAADLUSES ÕPILASTELE

Põltsamaa Felixhall

29.11.2015

Weight category Kaal

85 KG

Place Koht	Tour Préliminaire Eelring	1/4 Finale 1/4 Finaal	1/2 Finale 1/2 Finaal	Finale 1.-2. Finaal 1.-2.							
5	1 ROBIN KUKK, Rakvere	1 ROBIN KUKK, Rakvere <table border="1"><tr><td>0</td><td>0</td></tr></table>	0	0	2 GEORG KOVZAROV, Aberg <table border="1"><tr><td>4</td><td>10</td></tr></table>	4	10	2 GEORG KOVZAROV, Aberg <table border="1"><tr><td>4</td><td>10</td></tr></table>	4	10	2 GEORG KOVZAROV, Aberg
0	0										
4	10										
4	10										
1	2 GEORG KOVZAROV, Aberg	2 GEORG KOVZAROV, Aberg <table border="1"><tr><td>5</td><td>6</td></tr></table>	5	6							
5	6										
9	3 ARTUR RAKITIN, Delta <table border="1"><tr><td>0</td><td>6</td></tr></table>	0	6	3 ARTUR RAKITIN, Delta <table border="1"><tr><td>0</td><td>0</td></tr></table>	0	0	4 GREGOR NAATAN SOONE, Aberg <table border="1"><tr><td>0</td><td>0</td></tr></table>	0	0		
0	6										
0	0										
0	0										
3	4 GREGOR NAATAN SOONE, Aberg	4 GREGOR NAATAN SOONE, Aberg <table border="1"><tr><td>5</td><td>6</td></tr></table>	5	6	6 VIRMO TAMMEMÄGI, V-M <table border="1"><tr><td>0</td><td>0</td></tr></table>	0	0				
5	6										
0	0										
7	5 RICHARD KARELSON, Nelson <table border="1"><tr><td>1</td><td>6</td></tr></table>	1	6	5 RICHARD KARELSON, Nelson <table border="1"><tr><td>1</td><td>5</td></tr></table>	1	5	7 NIKITA VINOGRADOV, Dünamo <table border="1"><tr><td>0</td><td>0</td></tr></table>	0	0		
1	6										
1	5										
0	0										
3	6 VIRMO TAMMEMÄGI, V-M	6 VIRMO TAMMEMÄGI, V-M <table border="1"><tr><td>3</td><td>6</td></tr></table>	3	6	7 NIKITA VINOGRADOV, Dünamo <table border="1"><tr><td>5</td><td>6</td></tr></table>	5	6				
3	6										
5	6										
2	7 NIKITA VINOGRADOV, Dünamo	7 NIKITA VINOGRADOV, Dünamo <table border="1"><tr><td>5</td><td>6</td></tr></table>	5	6	9 RUDOLF PRAGI, Lapiti <table border="1"><tr><td>0</td><td>6</td></tr></table>	0	6				
5	6										
0	6										
8	8 JAKKO RAIK, K-J Kalev <table border="1"><tr><td>0</td><td>2</td></tr></table>	0	2	8 JAKKO RAIK, K-J Kalev <table border="1"><tr><td>0</td><td>0</td></tr></table>	0	0	7 NIKITA VINOGRADOV, Dünamo <table border="1"><tr><td>5</td><td>6</td></tr></table>	5	6		
0	2										
0	0										
5	6										
5	9 RUDOLF PRAGI, Lapiti <table border="1"><tr><td>5</td><td>2</td></tr></table>	5	2	9 RUDOLF PRAGI, Lapiti <table border="1"><tr><td>0</td><td>6</td></tr></table>	0	6					
5	2										
0	6										

CHIEF OF OFFICIALS  
CHIEF OF SECRETARY

Vello Aava  
Kätri-Avelin Säärits

## REPECHAGE / LOHUTUSRINGID

Perdants contre le 1er Finaliste  
Esimesele finalistile kaotajad

Perdants contre le 2ème Finaliste  
Teisele finalistile kaotajad

	1 ROBIN KUKK, Rakvere <table border="1"><tr><td>0</td><td>2</td></tr></table>	0	2		9 RUDOLF PRAGI, Lapiti <table border="1"><tr><td>0</td><td>0</td></tr></table>	0	0
0	2						
0	0						
	4 GREGOR NAATAN SOONE, Aberg <table border="1"><tr><td>5</td><td>10</td></tr></table>	5	10		6 VIRMO TAMMEMÄGI, V-M <table border="1"><tr><td>5</td><td>10</td></tr></table>	5	10
5	10						
5	10						
Médaille de Bronze Pronksmedali võitja	4 GREGOR NAATAN SOONE, Aberg	Médaille de Bronze Pronksmedali võitja	6 VIRMO TAMMEMÄGI, V-M				

EESTI MV VABA- JA NAISTEMAADLUSES ÕPILASTELE

Põltsamaa Felixhall

29.11.2015

Weight category	T37	kg
-----------------	-----	----

Name	Weight	Country	Pools competitions								Points	Place
			1.round								Kval.	
			Passivity	Time							Tehn.	

**1.pool**

JANA DEINEKIN, Ramm	2										0	1
											0	
2	1										0	
											0	

CHIEF OF OFFICIALS	Vello Aava
CHIEF OF SECRETARY	Kätri-Avelin Säärits



# EESTI MV VABA- JA NAISTEMAADLUSES ÖPILASTELE

Põltsamaa Felixhall

29.11.2015

Weight category Kaal T44 kg

Place Koht	Tour Préliminaire Eelring	1/2 Finale 1/2 Finaal	Finale 1.-2. Finaal 1.-2.
5	1 MARET KANE, Juhan $\frac{5}{8}$	1 MARET KANE, Juhan $\frac{0}{0}$	3 TRIINULY VEIMANN, Juhan $\frac{1}{8}$
8	2 SANDRA LEPPIK, Valga $\frac{0}{0}$		
2	3 TRIINULY VEIMANN, Juhan $\frac{5}{6}$	3 TRIINULY VEIMANN, Juhan $\frac{5}{6}$	8 TIIA-TRIIN TOMSON, Leo
3	4 JONETE VISNAPUU, V-M $\frac{0}{0}$		
3	5 POLINA SAHNO, Tapa $\frac{5}{4}$	5 POLINA SAHNO, Tapa $\frac{0}{0}$	8 TIIA-TRIIN TOMSON, Leo $\frac{3}{9}$
7	6 EVA KOVALJOVA, Palusalu $\frac{0}{0}$		
5	7 MAARJA PLASER, Korrus 3 $\frac{0}{0}$	8 TIIA-TRIIN TOMSON, Leo $\frac{4}{12}$	
1	8 TIIA-TRIIN TOMSON, Leo $\frac{5}{10}$		

## REPECHAGE / LOHUTUSRINGID

Perdants contre le 1er Finaliste  
Esimesele finalistile kaotajad

4	JONETE VISNAPUU, V-M	$\frac{5}{13}$
1	MARET KANE, Juhan	$\frac{0}{4}$

4 JONETE VISNAPUU, V-M  
↑  
Médaille de Bronze Pronksmedali  
võitja

Perdants contre le 2ème Finaliste  
Teisele finalistile kaotajad

7	MAARJA PLASER, Korrus 3	$\frac{0}{4}$
5	POLINA SAHNO, Tapa	$\frac{5}{8}$

5 POLINA SAHNO, Tapa  
↑  
Médaille de Bronze Pronksmedali  
võitja

CHIEF OF OFFICIALS  
CHIEF OF SECRETARY

Vello Aava  
Kättri-Avelin Säärts

**EESTI MV VABA- JA NAISTEMAADLUSES ÕPILASTELE**  
**Põltsamaa Felixhall**  
**29.11.2015**

**Weight category Kaal T52 kg**

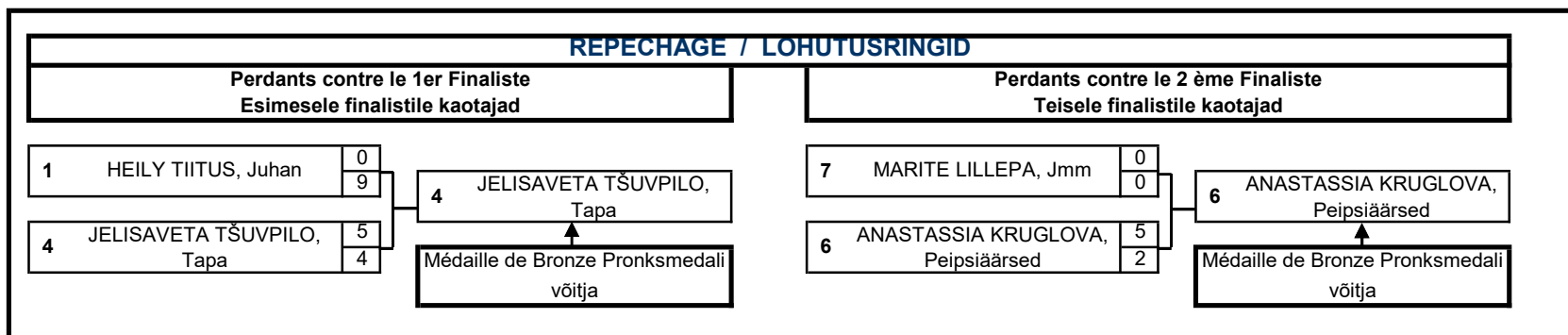
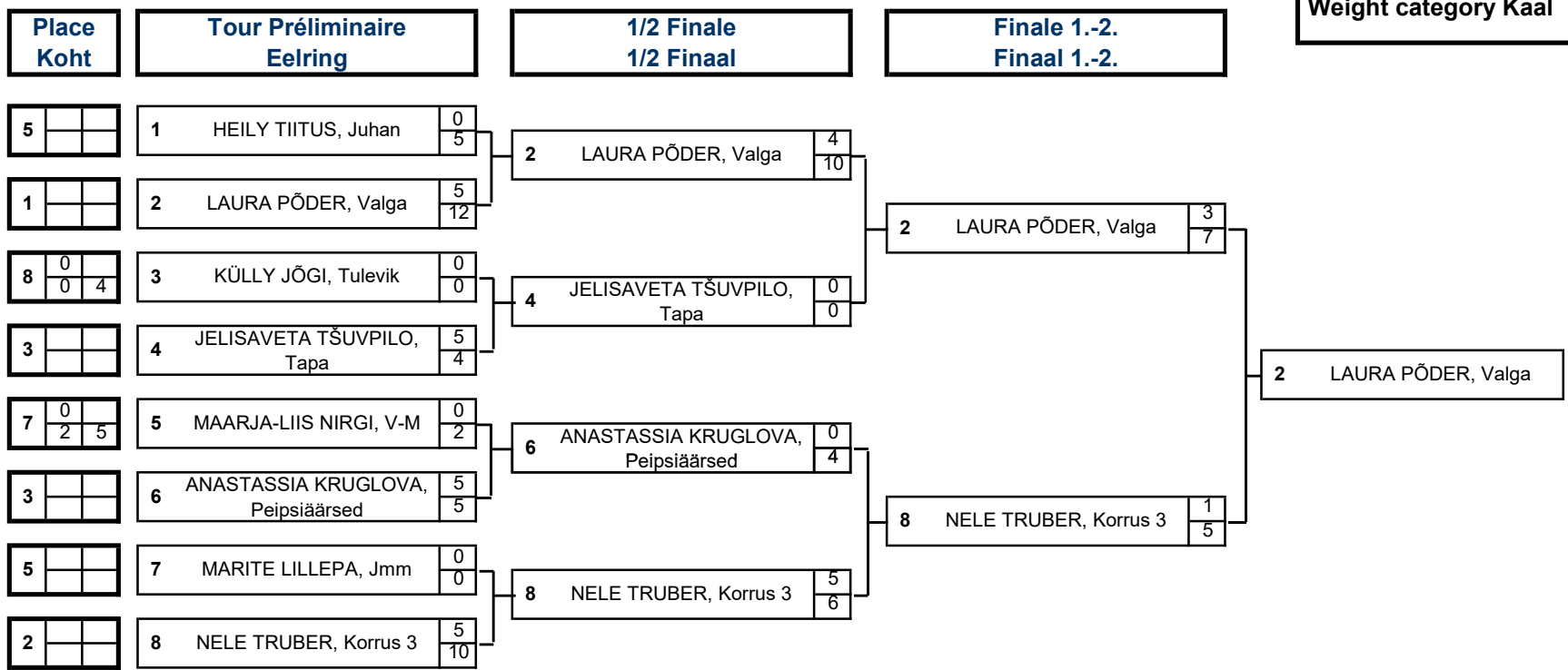

CHIEF OF OFFICIALS  
 CHIEF OF SECRETARY

Vello Aava  
 Kätri-Avelin Säärits

# EESTI MV VABA- JA NAISTEMAADLUSES ÕPILASTELE

Põltsamaa Felixhall

29.11.2015

Weight category Kaal T62 kg

Place Koht	Tour Préliminaire Eelring	1/2 Finale 1/2 Finaal	Finale 1.-2. Finaal 1.-2.
5	1 VLADLENA STEPTSENKO, Põltsamaa	1 VLADLENA STEPTSENKO, 0 Põltsamaa 0	3 MARTA PAJULA, Tapa 0 2
3	2 TEELE-HELENA PALU, Tulevik 0 0	3 MARTA PAJULA, Tapa 5 6	
2	3 MARTA PAJULA, Tapa 5 4	5 KÄROLY SEEMANN, V-M 0 0	6 VIKTORIA VESSO, EMÜ 5 9
7	4 RAGNE KUURMAA, Jmm 0 0		
3	5 KÄROLY SEEMANN, V-M 4 10	6 VIKTORIA VESSO, EMÜ 5 10	
1	6 VIKTORIA VESSO, EMÜ 5 10		
5	7 KARMEN KUKK, Wesenberg 0 0		

## REPECHAGE / LÖHUTUSRINGID

Perdants contre le 1er Finaliste  
Esimesele finalistile kaotajad

2	TEELE-HELENA PALU, Tulevik	5 5
1	VLADLENA STEPTSENKO, Põltsamaa	0 0

2 TEELE-HELENA PALU,  
Tulevik  
↑  
Médaille de Bronze Pronksmedali  
võitja

Perdants contre le 2ème Finaliste  
Teisele finalistile kaotajad

7	KARMEN KUKK, Wesenberg	0 0
5	KÄROLY SEEMANN, V-M	5 6

5 KÄROLY SEEMANN, V-M  
↑  
Médaille de Bronze Pronksmedali  
võitja

CHIEF OF OFFICIALS  
CHIEF OF SECRETARY

Vello Aava  
Kätri-Avelin Säärts

**EESTI MV VABA- JA NAISTEMAADLUSES ÕPILASTELE**  
**Põltsamaa Felixhall**  
**29.11.2015**

KLUBID													
		32	35	38	42	47	53	59	66	73	85	PUNKTID	KOHT
1	SK KULDKARU	7			7 2	7 5			7			35	1
2	MK ABERG			5 4		4					7 4	24	2
3	MK LAPITI			7	4			5			2	18	3
4	MK JUHAN					4			5 2	4 2		17	4
5	MK NELSON						7 2	7				16	5
6	SK KADRINA				2		2	4	4	4		16	6
7	PÕLTSAMAA SK	4				2		2		7		15	7
8	MK JAAN		7				5					12	8
9	JMM		5	2			4					11	9
10	SK TAPA			2	5		4					11	9
11	SK LEO	5			4			2				11	9
12	VÄIKE-MAARJA					2			4		4	10	12
13	MK DÜNAMO										5	5	13
14	K. PALUSALU SK									5		5	13
15	SK ENGLAS/ TARTU SS KALEV			4								4	15
16	SK RAKVERE									2	2	4	16
17	TARTUMAA ML							4				4	16
18	MK TULEVIK								2			2	18
19	RAMM											0	19-27
20	SKP											0	19-27
21	EMÜ SK											0	19-27
22	TÜ ASK											0	19-27
23	VALGA SK											0	19-27
24	LEOLA											0	19-27
25	WESENBERG											0	19-27
26	DELTA											0	19-27
27	K-JÄRVE KALEV											0	19-27

EESTI MEISTRIVÕISTLUSED NAISTEMAADLUSES / VÕISTKONDLIK ARVESTUS

Põltsamaa Felixhall

29.11.2015

KLUBID		EMV ÕPILASED					KADETID	JUUNIORID	TÄISKASV.		
		32	37	44	52	62	PUNKTID KOKKU	PUNKTID KOKKU	PUNKTID KOKKU	PUNKTID	KOHT
1	SK TAPA			4	4	5	21		4	38	1
2	MK TULEVIK					4	8	7	16	35	2
3	EMÜ SK					7	7		18	32	3
4	KULDKARU						4	11	12	27	4
5	MK JUHAN			5 2	2		11	5		25	5
6	VALGA SK				7		5	5	6	23	6
7	TÜ ASK							7	14	21	7
8	SK BUFFEN-DO							4	15	19	8
9	SK RAKVERE						4	4	10	18	9
10	SK LEO			7			4		5	16	10
11	SK MARTNA						7	3	5	15	11
12	SK SAKURA							7	7	14	12
13	RAMM		7					7		14	12
14	J. KOTKASE SK						1	7	4	12	14
15	SK NIPI					2		5	4	11	15
16	KORRUS 3			2	5		3			10	16
17	SK PEIPSIÄÄRSED				4		5			9	17
18	VÄIKE-MAARJA			4		4				8	18
19	KJ SK								7	7	19
20	MK NELSON								5	5	20
21	TARTU KALEV / ENGLAS								4	4	21
22	JMM				2					2	22
23	K. PALUSALU SK						2			2	22
24	MK ABERG						2			2	22
25	WESENBERG					2			16	2	22

Võistluste nimi

**EESTI MV VABA- JA**

**NAISTEMAADLUSES ÕPILASTELE**

Toimumise koht

**Põltsamaa Felixhall**

Kuupäev

**29.11.2015**

Peakohtunik

**Vello Aava**

Peasekretär

**Kättri-Avelin Säärits**